



TRU/FLO® COMPOUND METER

SIZES: 2" HP, 3", 4", 6", AND 6" X 8"

TRU/FLO® meters combine the low-flow sensitivity of a disc-type meter with the high-flow capacity of a turbine-type meter.



All TRU/FLO® Compound water meters meet or exceed the latest performance and accuracy requirements set by the AWWA C702, and maximum continuous flow rates may be exceeded by as much as 25% for intermittent periods.

APPLICATION

The TRU/FLO Compound water meter is designed to register wide flow ranges where varying flow rates are typical. TRU/FLO meters combine the low-flow sensitivity of a disc-type meter with the high-flow capacity of a turbine-type meter.

OPERATION

The hydraulic valve transfers flow smoothly between the disc section and turbine section of the meter, minimizing the loss of accuracy in the crossover range. The turbine measuring element registers high flows and the disc measuring element registers low flows, ensuring accurate measurement at all flow rates.

CONSTRUCTION

The TRU/FLO consists of a durable lead free, high-copper alloy maincase, Neptune High Performance (HP) or Trident® Turbine measuring element, Neptune T-10 chamber, and two magnetic-driven, roll-sealed registers.

The 6" x 8" TRU/FLO assembly consists of two 6" x 8" concentric reducers, a 6" Neptune strainer, and a 6" Neptune TRU/FLO Compound meter.

The lead free, high-copper maincase is corrosion-resistant, lightweight, and easy to handle.

A calibration vane allows field calibration of the UME to lengthen service life and to ensure accurate registration.

The two magnetic-driven, roll-sealed registers simplify the meter's design and reduce long-term maintenance by eliminating complicated combining drive mechanisms. For reading convenience, the registers can be mounted in any one of four positions on the meter.

WARRANTY

Neptune provides a limited warranty with respect to its TRU/FLO Compound water meters for performance, materials, and workmanship.

When desired, owner maintenance is easily accomplished by in-line replacement of major components, or a factory-calibrated UME.

KEY FEATURES

- Minimum loss of accuracy in the crossover range increases revenue
- Spring-loaded valve eliminates need for frequent adjustment and service
- Combined turbine and disc measuring elements
 - Industry-leading flow ranges at 98.5%–101.5% accuracy ensure maximum revenue
 - Direct coupling of rotor to gear train ensures accurate registration
 - Unitized Measuring Element (UME) makes maintenance easier and faster with less downtime
 - Calibration vane allows in-line service to extend life and ensure accurate registration
- Compact maincase
 - Made from lead free, high-copper alloy
 - NSF/ANSI 372 certified and NSF/ANSI 61 compliant
 - Lifetime guarantee
 - Compact, lightweight design provides for easy installation and in-line serviceability

SYSTEMS COMPATIBILITY

Adaptability to all present and future systems for flexibility.

2" ACCURACY

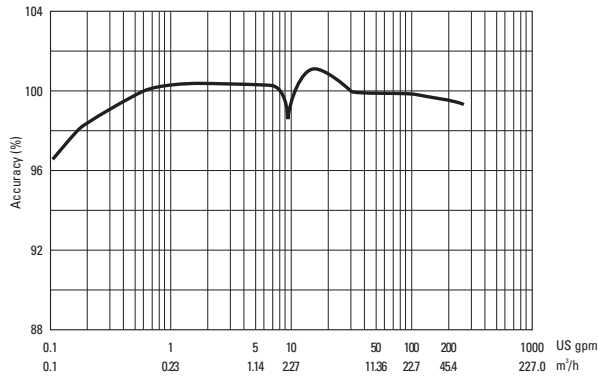

2" PRESSURE LOSS

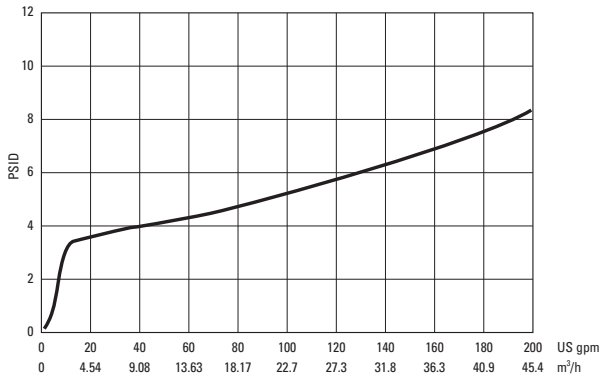

3" ACCURACY

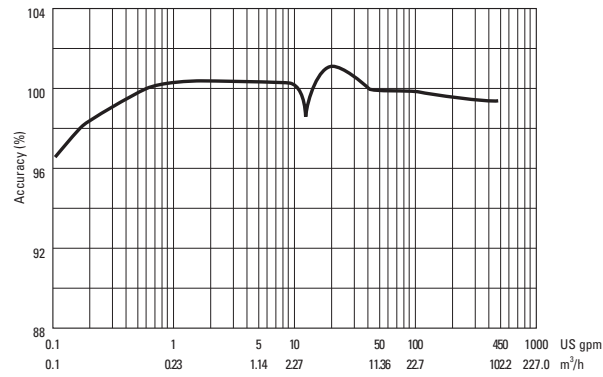

3" PRESSURE LOSS

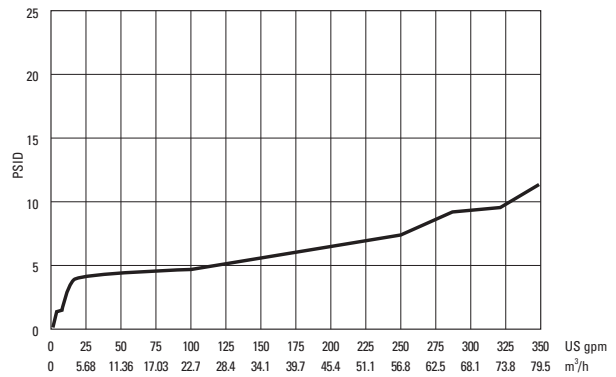

4" ACCURACY

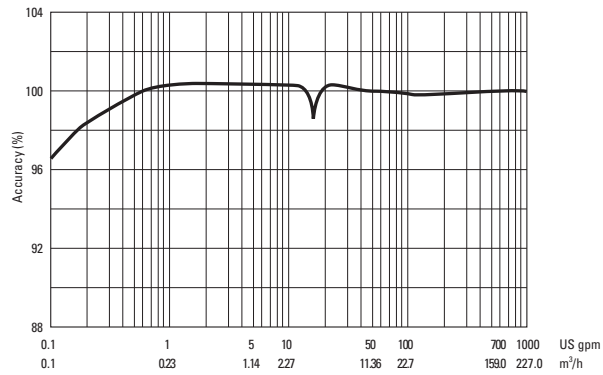

4" PRESSURE LOSS

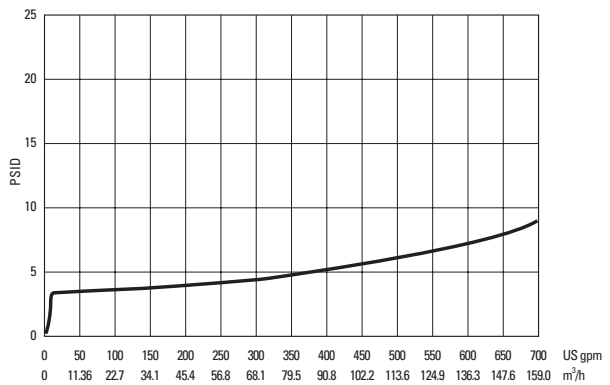

6" ACCURACY

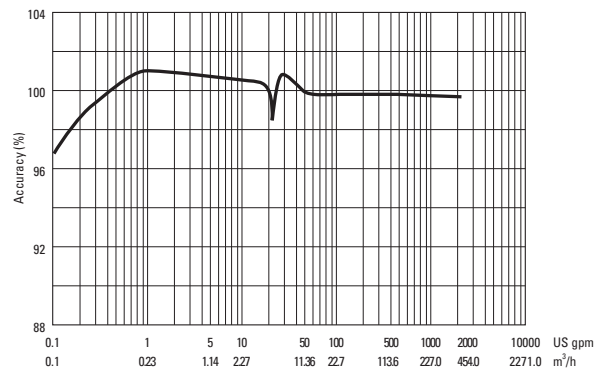

6" PRESSURE LOSS

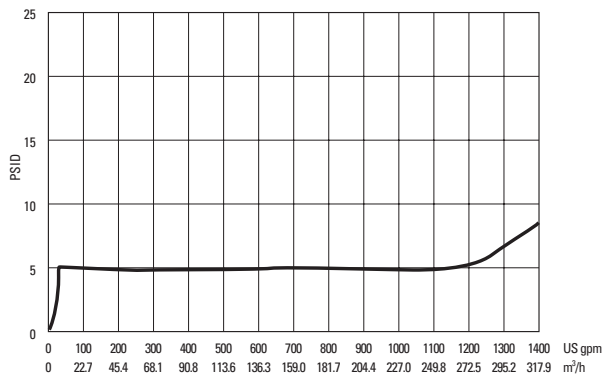

OPERATING CHARACTERISTICS

Meter Size	Normal Operating Range @100% Accuracy (±1.5%)	AWWA Standard	Low Flow @ 95% Accuracy
2"	½ to 200 US gpm 0.11 to 45.4 m³/h	1 to 160 US gpm .227 to 36.34 m³/h	⅙ US gpm 0.03 m³/h
3"	½ to 450 US gpm 0.11 to 102.2 m³/h	2 to 350 US gpm .454 to 79.5 m³/h	⅙ US gpm 0.03 m³/h
4"	1 to 1000 US gpm 0.23 to 227.1 m³/h	3 to 600 US gpm .68 to 136.3 m³/h	⅙ US gpm 0.11 m³/h
6"	1 ½ to 2000 US gpm 0.34 to 454.2 m³/h	5 to 1350 US gpm 1.14 to 306.6 m³/h	¾ US gpm 0.17 m³/h
6" x 8"	1 ½ to 2000 US gpm 0.34 to 454.2 m³/h	16 to 1600 US gpm 3.63 to 363.4 m³/h	¾ US gpm 0.17 m³/h

DIMENSIONS

Meter Size	B				C in/mm	D in/mm	E in/mm	F in/mm	G in/mm	Flange Type	Weight lbs/kg
	A in/mm	E-Coder® in/mm	ProRead™ in/mm	E-Coder®) R900j™ in/mm							
2" HP	15 ¼ 387	9 ⅜ 238	9 ⅞ ₁₆ 243	9 ⅜ 238	2 ½ 64	1 ⅞ ₁₆ 21	5 ⅞ 149	6 152	1 ½ NPT 38	2" Oval 150 lb	32 14.5
3"	17 432	11 ½ 292	11 ¾ 298	11 ½ 292	3 ¾ 95	5 ⅞ 16	7 ½ 191	8 ½ 216	1 ½ NPT 38	3" ANSI 150 lb	72 32.7
4"	20 508	13 ⅜ 340	13 ⅞ ₁₆ 345	13 ⅜ 340	4 ½ 114	1 11 ⅞ ₁₆ 17	9 229	9 ⅞ 232	2 NPT 51	4" ANSI 150 lb	100 45.4
6"	24 610	16 ⅜ 416	16 ⅞ ₁₆ 421	16 ⅜ 416	5 ½ 140	1 25	11 279	12 ¾ 324	2 NPT 51	6" ANSI 150 lb	208 94.3
6" x 8"	55 ⅜ 1407	16 ⅜ 416	16 ⅞ ₁₆ 421	16 ⅜ 416	5 ½ 140	1 25	11 279	12 ¾ 232	2 NPT 51	8" ANSI 150 lb	460 208.50

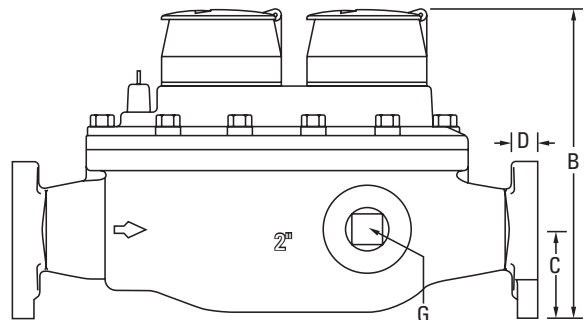
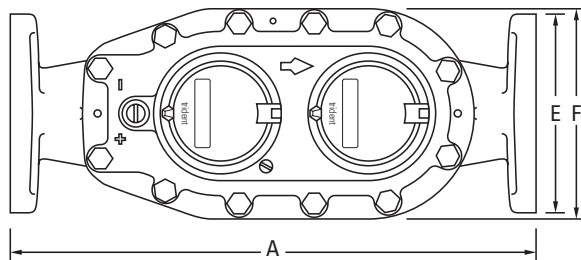

GUARANTEED SYSTEMS COMPATIBILITY

All Neptune TRU/FLO Compound meters are guaranteed adaptable to our ARB®V, ProRead™ (ARB VI), E-Coder®, E-Coder®)R900i™, E-Coder®)R450i™, TRICON®/S, TRICON/E®3, and Neptune meter reading systems without removing the meter from service.

REGISTRATION

Registration (per sweep hand revolution)	Turbine Side		Disc Side
	2", 3", 4"	6", 6" x 8"	2", 3", 4", 6", 6" x 8"
1,000 US Gallons		✓	
1,000 Imperial Gallons		✓	
100 US Gallons	✓		
100 Imperial Gallons	✓		
100 Cubic Feet		✓	
10 US Gallons			✓
10 Imperial Gallons			✓
10 Cubic Feet	✓		
10 Cubic Metres		✓	
1 Cubic Foot			✓
1 Cubic Metre	✓		
0.1 Cubic Metre			✓

Register Capacity (6-wheel odometer)	Turbine Side		Disc Side
	2", 3", 4"	6", 6" x 8"	2", 3", 4", 6", 6" x 8"
1,000,000,000 US Gallons		✓	
1,000,000,000 Imperial Gallons		✓	
100,000,000 US Gallons	✓		
100,000,000 Imperial Gallons	✓		
100,000,000 Cubic Feet		✓	
10,000,000 US Gallons			✓
10,000,000 Imperial Gallons			✓
10,000,000 Cubic Feet	✓		
10,000,000 Cubic Metres		✓	
1,000,000 Cubic Feet			✓
1,000,000 Cubic Metres	✓		
100,000 Cubic Metres			✓

SPECIFICATIONS

- Application: cold water measurement of flow in one direction
- Maximum operating pressure: 150 psi (1034 kPa)
- Maximum operating temperature: 80°F
- Register: direct reading, center sweep, roll-sealed, magnetic drive with low-flow indicator
- Measuring element:
 - AWWA Class II Turbine, hydrodynamically balanced rotor
 - Nutating disc

OPTIONS

- Sizes: 2" HP, 3", 4", 6", and 6" x 8"
- Units of measure: U.S. gallons, imperial gallons, cubic feet, cubic metres
- Register types:
 - Direct reading: bronze box and cover (standard)
 - Remote reading systems*: ProRead, E-Coder, E-Coder)R900i, E-Coder)R450i, TRICON/S, TRICON/E3
 - Reclaim
- Companion flanges:
 - 2", 3", 4" bronze or cast iron
 - 6", 6" x 8" cast iron
- Strainer: 2", 3", 4", 6" NSF/ANSI 372 and NSF/ANSI 61 lead free, high-copper alloy

* Consult factory for meter performance specifications when fitted with ARB.

Neptune Technology Group Inc.
1600 Alabama Highway 229
Tallahassee, AL 36078
USA
Tel: (800) 633-8754
Fax: (334) 283-7293

Neptune Technology Group (Canada) Ltd.
7275 West Credit Avenue
Mississauga, Ontario
L5N 5M9
Canada
Tel: (905) 858-4211
Fax: (905) 858-0428

Neptune Technology Group Inc.
Avenida Ejercito Nacional No 418
Piso 12, Despacho 1203
Colonia Polanco V Sección
C.P. 11560
Delegación, Miguel Hidalgo
Mexico D.F.
Tel: (525) 5203-4032 / (525) 5203-6204
(525) 5203-5294
Fax: (525) 5203-6503

